

Art.-Nr. | Gerät

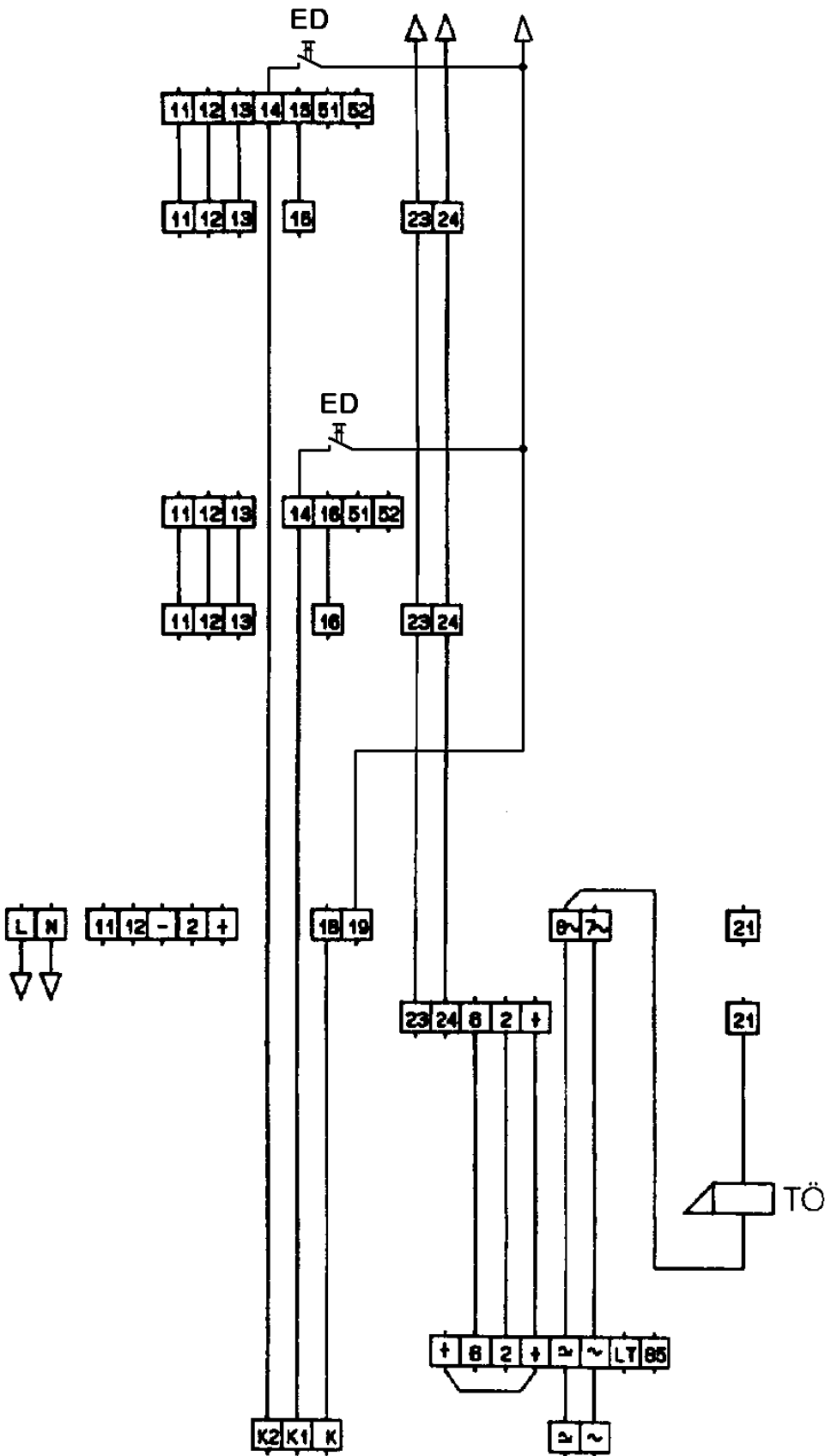

6530/..



6542/00

6530/..



6542/00

6990
alt.
6991



6573/02



6582/00

5760/..



5752/..

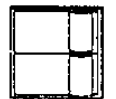

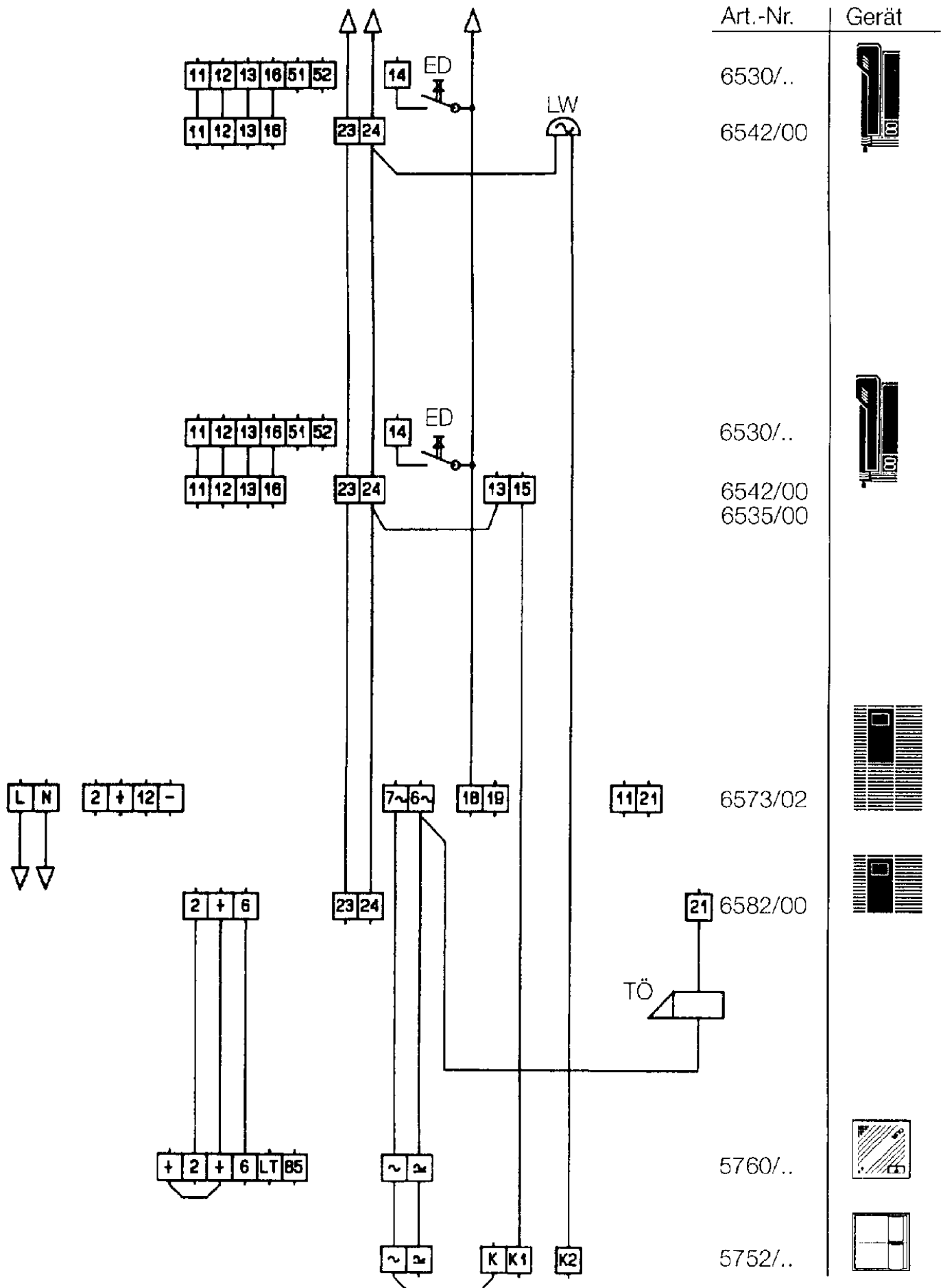

TÖ = Türöffner
 LW = Läutewerk, extern
 ED = Etagendrucker

Art.-Nr. | Gerät

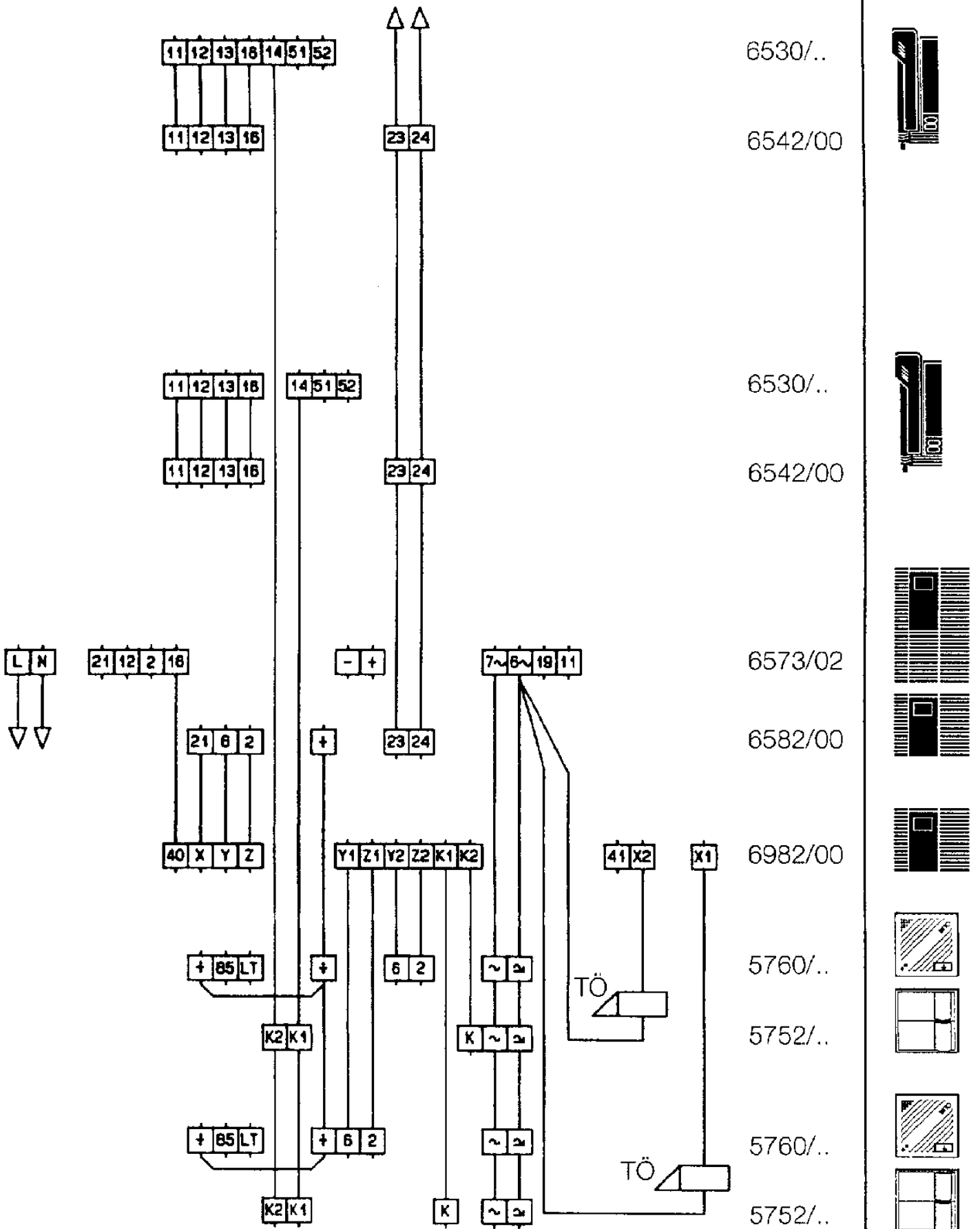

6530/..



6542/00

6530/..



6542/00

6573/02



6582/00



6982/00



5760/..



5752/..

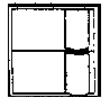

5760/..



5752/..

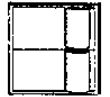

Art.-Nr. | Gerät

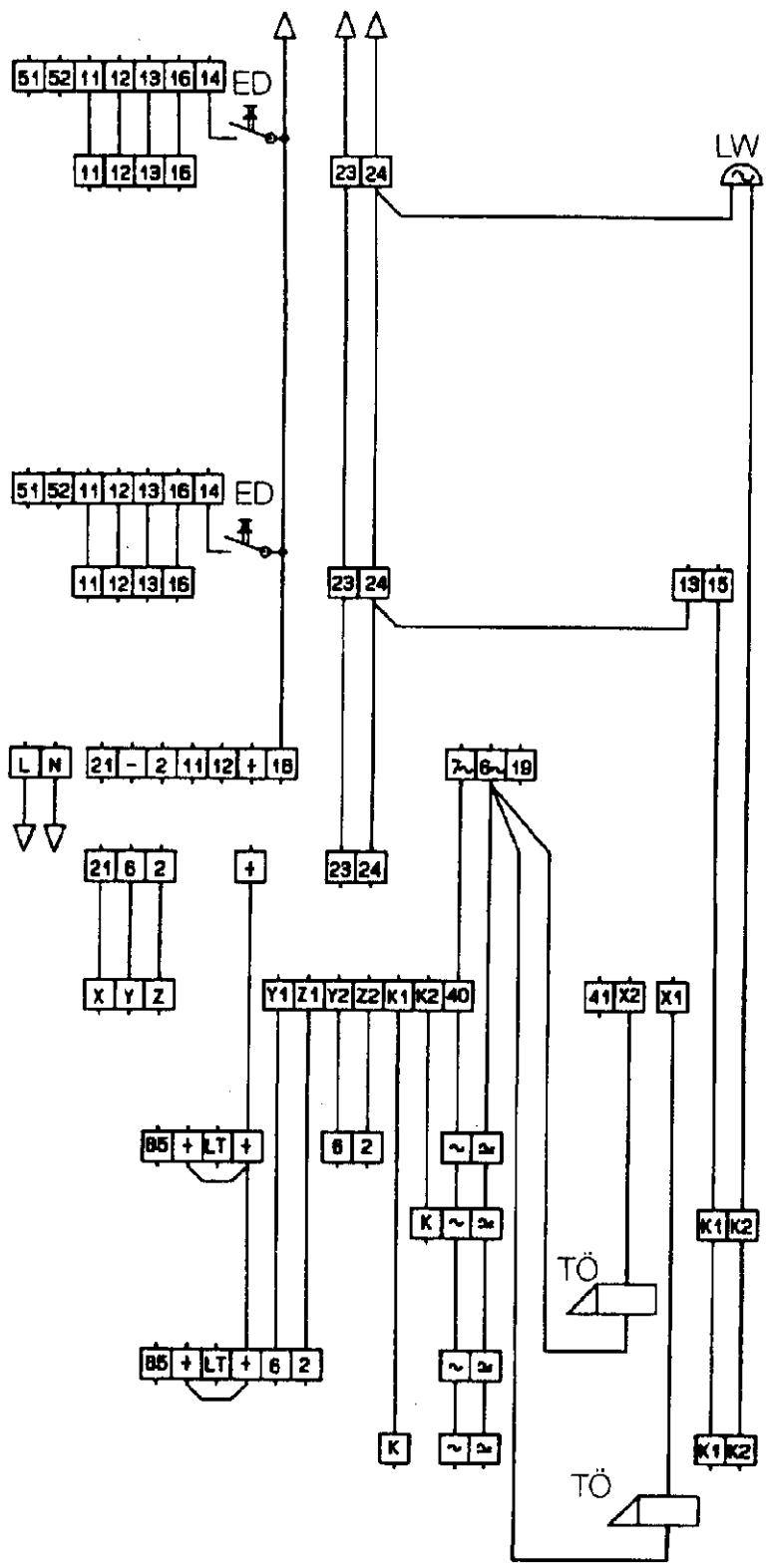

6530/..

6542/00

6530/..

6542/00
6535/00

6573/02

6582/00

6982/00

5760/..

5752/..

5760/..

5752/..

